



UNIVERSITY OF CAMBRIDGE INTERNATIONAL EXAMINATIONS  
International General Certificate of Secondary Education

CANDIDATE  
NAME

CENTRE  
NUMBER

--	--	--	--	--

CANDIDATE  
NUMBER

--	--	--	--

\* 2 9 7 3 9 0 7 8 2 9 \*

**CHEMISTRY**

**0620/02**

Paper 2

**October/November 2009**

**1 hour 15 minutes**

Candidates answer on the Question Paper.

No Additional Materials are required.

**READ THESE INSTRUCTIONS FIRST**

Write your Centre number, candidate number and name in the spaces at the top of this page.

Write in dark blue or black pen.

You may need to use a pencil for any diagrams, graphs or rough working.

Do not use staples, paper clips, highlighters, glue or correction fluid.

**DO NOT WRITE IN ANY BARCODES.**

Answer **all** questions.

A copy of the periodic table is printed on page 20.

At the end of the examination, fasten all your work securely together.

The number of marks is given in brackets [ ] at the end of each question or part question.

For Examiner's Use	
1	
2	
3	
4	
5	
6	
7	
<b>Total</b>	

This document consists of **17** printed pages and **3** blank pages.



1 The list shows some non-metallic elements.

bromine  
carbon  
fluorine  
krypton  
nitrogen  
oxygen

For  
Examiner's  
Use

(a) Which **two** elements in the list are in the same Group of the Periodic Table?

..... and ..... [1]

(b) Which element in the list has the highest proton number?

..... [1]

(c) Which **two** of these elements make up most of the air?

..... and ..... [1]

(d) Bromine and fluorine form a compound with the formula  $\text{BrF}_5$ .  
Calculate the relative molecular mass of  $\text{BrF}_5$ .

[1]

(e) The diagram shows the structure of some compounds containing oxygen.

A

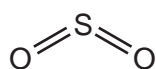

B

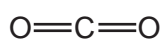

C

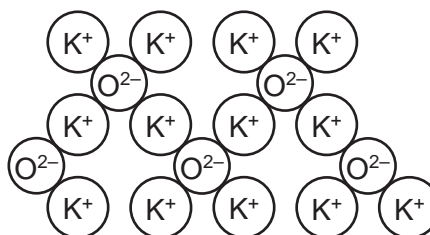

D



(i) What type of oxide is compound **C**?

..... [1]

- (ii) Compound **A** is an atmospheric pollutant.  
Describe the source of compound **A** and state its effect on the environment.

Source .....

Effect on the environment .....

[2]

- (iii) In the presence of air, compound **D** reacts with water to form nitric acid.

A student used the apparatus below to add an aqueous solution of nitric acid to an aqueous solution of potassium hydroxide. He added the acid until it was in excess.

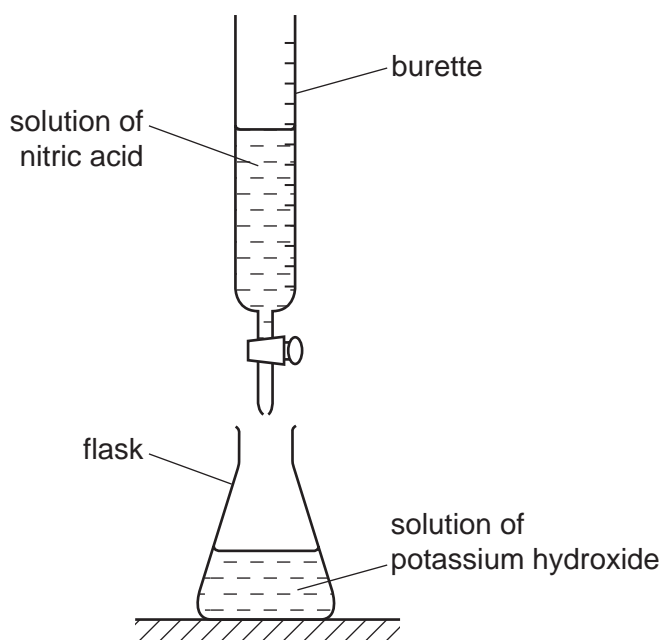

Describe how the pH of the solution in the flask changes as the nitric acid is added until the acid is in excess.

.....  
.....

[3]

- (iv) Describe how you can measure this pH change.

..... [1]

- (v) The equation for the reaction is

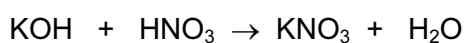

State the name of the salt formed in this reaction.

..... [1]

[Total: 12]

For  
Examiner's  
Use

- 2 (a) Link the terms in the boxes on the left with the definitions on the right. The first one has been done for you.

For  
Examiner's  
Use

atom	a substance containing different atoms or ions bonded together
compound	a substance made up of one type of atom
element	the smallest part of an element which takes part in a chemical reaction
ion	the smallest group of covalently bonded atoms which can exist on its own
molecule	a charged atom or group of atoms

[4]

- (b) Which **two** of the following are mixtures?  
Tick two boxes.

air

graphite

sodium chloride

steel

[1]

- (c) (i) Draw a labelled diagram to show the atomic structure of an atom of helium. In your diagram include the structure of the nucleus.

For  
Examiner's  
Use

[4]

- (ii) State a use for helium.

..... [1]

- (iii) Which one of these statements about helium is correct?

helium is in Period 2 of the Periodic Table

helium is a liquid at room temperature

helium is unreactive

helium has an incomplete outer shell of electrons

[1]

[Total: 11]

- 3 A student used the apparatus shown to calculate the energy released when ethanol burns.

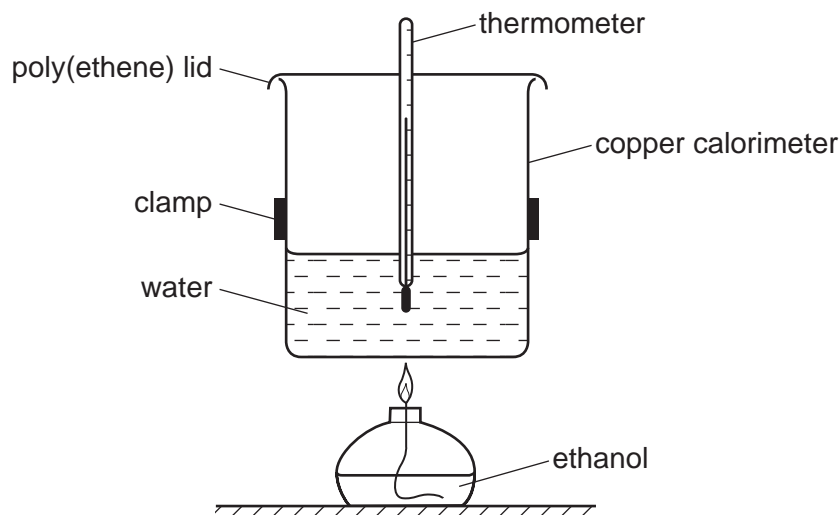

For  
Examiner's  
Use

- (a) Draw the structure of ethanol showing all atoms and bonds.

[1]

- (b) The energy released by the burning ethanol raises the temperature of the water in the copper calorimeter.

- (i) Which one of these words best describes the energy change when ethanol burns?  
Put a ring around the correct answer.

**electrolytic**

**electronic**

**endothermic**

**exothermic**

[1]

- (ii) When 4.6 g of ethanol is burnt, 5.4 g of water is formed.  
Calculate the mass of water formed when 13.8 g of ethanol is burnt.

[1]

(iii) Complete the equation for the combustion of ethanol.



For  
Examiner's  
Use

(c) The calorimeter is made of copper. Copper is a transition metal.  
State two properties which distinguish transition metals from Group I metals.

.....  
..... [2]

(d) When copper is left exposed to the air for some time, a coating of copper carbonate forms on its surface. The equation shows how copper carbonate reacts with hydrochloric acid.

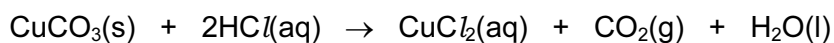

(i) Describe two observations that can be made as this reaction happens.

1. .... [2]
2. .... [2]

(ii) State the meaning of the symbol (aq).

..... [1]

(e) The calorimeter lid is made of poly(ethene).  
Complete these sentences about poly(ethene) using words from the list.

<b>acids</b>	<b>addition</b>	<b>condensation</b>	<b>ethane</b>	<b>ethene</b>
	<b>monomers</b>		<b>polymer</b>	

Poly(ethene) is a ..... formed by the ..... of ethene molecules.

In this reaction the ethene molecules can be described as .....

[3]

[Total: 12]

4 Caesium is a metal in Group I of the Periodic Table.

(a) State two physical properties of caesium.

.....  
 ..... [2]

(b) State the number of electrons in the outer shell of a caesium atom.

..... [1]

(c) An isotope of caesium has a mass number of 133.

(i) What do you understand by the term *isotope*?

..... [1]

(ii) Calculate the number of neutrons in this isotope of caesium.

..... [1]

(d) Complete the following table to estimate the boiling point of caesium and predict the reactivity of caesium with water.

Group I metal	density / g/cm <sup>3</sup>	boiling point / °C	reactivity with water
sodium	0.97	883	fizzes quickly, disappears gradually and does not burst into flame
potassium	0.86	760	fizzes very quickly, disappears quickly and bursts into flame with a little spitting
rubidium	1.53	686	fizzes extremely quickly, bursts into flame then spits violently and may explode
caesium	1.88		

[2]

For  
Examiner's  
Use



(e) The diagram shows the structure of caesium chloride.

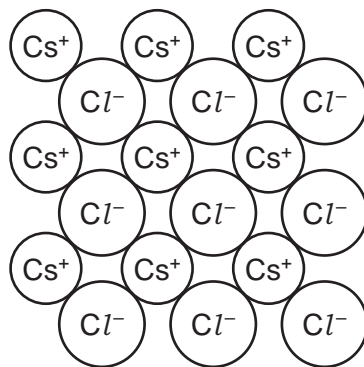

Use this diagram to work out the simplest formula for caesium chloride.

..... [1]

(f) Caesium chloride dissolves in water to form a neutral solution.  
State the pH of a neutral solution.

..... [1]

(g) Describe a test for chloride ions.

test .....

result .....

..... [2]

[Total: 11]

For  
Examiner's  
Use

- 5 Limonene is a colourless unsaturated hydrocarbon found in lemons. The structure of limonene is shown below.

For  
Examiner's  
Use

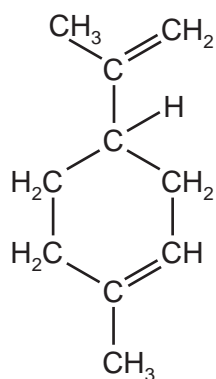

- (a) On the formula above, draw a circle around the bonds which make limonene an unsaturated compound. [1]

- (b) Write the molecular formula for a molecule of limonene.

..... [1]

- (c) Describe the colour change which occurs when excess limonene is added to a few drops of bromine water.

..... [2]

(d) Limonene can be extracted from lemon peel by steam distillation.

For  
Examiner's  
Use

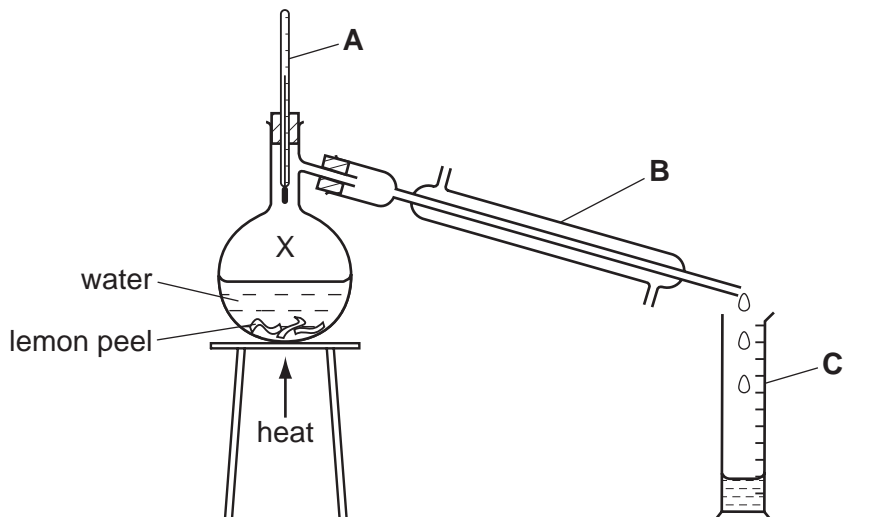

(i) State the name of the pieces of apparatus labelled **A**, **B** and **C**.

- A** .....
- B** .....
- C** ..... [3]

(ii) At point X on the diagram, the water is in the form of steam. Describe the arrangement and the movement of the particles in steam.

- arrangement .....
- movement ..... [2]

(e) When limonene undergoes incomplete combustion, carbon monoxide is formed.

(i) What do you understand by the term *incomplete combustion*?

..... [1]

(ii) State an adverse effect of carbon monoxide on health.

..... [1]

(f) The structures of some compounds found in plants are shown below.

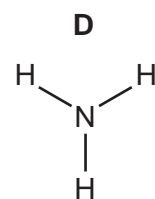
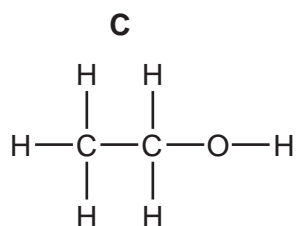
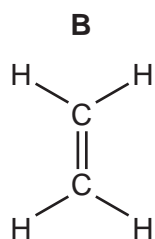
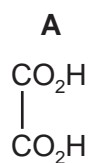

For  
Examiner's  
Use

(i) Which one of these compounds is a carboxylic acid? ..... [1]

(ii) Which one of these compounds is produced by the fermentation of glucose?

..... [1]

(iii) Which one of these compounds is a hydrocarbon? ..... [1]

[Total: 14]

6 Aluminium is extracted by the electrolysis of aluminium oxide.

For  
Examiner's  
Use

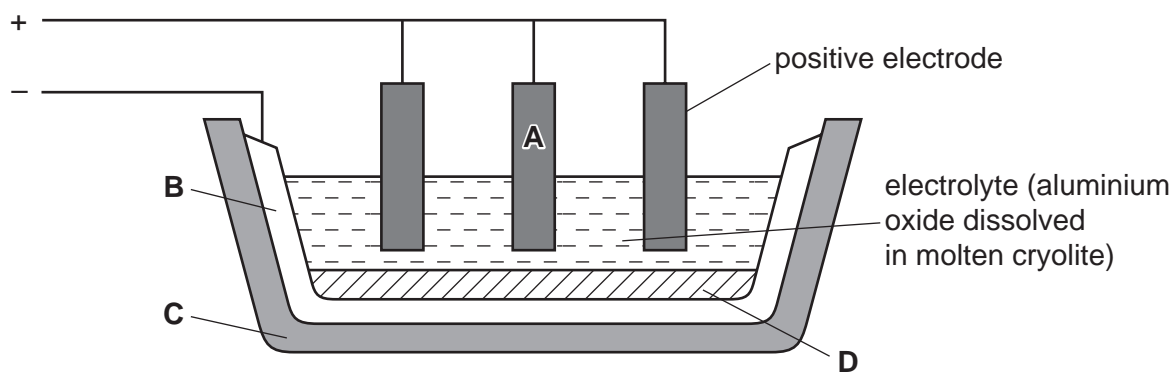

(a) Hydrated aluminium oxide is heated to produce pure aluminium oxide.

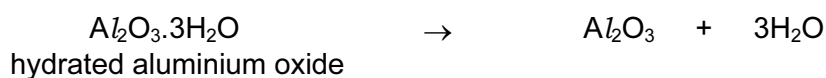

What type of reaction is this?  
Put a ring around the correct answer.

- decompositon      neutralisation      oxidation      reduction**

[1]

(b) Explain why the electrolyte must be molten for electrolysis to occur.

..... [1]

(c) What is the purpose of the cryolite?

..... [1]

(d) Which letter in the diagram, **A**, **B**, **C** or **D**, represents the cathode?

..... [1]

(e) State the name of the products formed at the anode and cathode during this electrolysis.

anode .....

cathode ..... [2]

(f) Why do the anodes have to be renewed periodically?

.....

..... [2]

14

(g) Complete the equation for the formation of aluminium from aluminium ions.

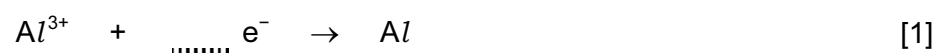

*For  
Examiner's  
Use*

(h) State one use of aluminium.

..... [1]

[Total: 10]

7 The diagram shows an experiment to investigate the rusting of some iron nails.

For  
Examiner's  
Use

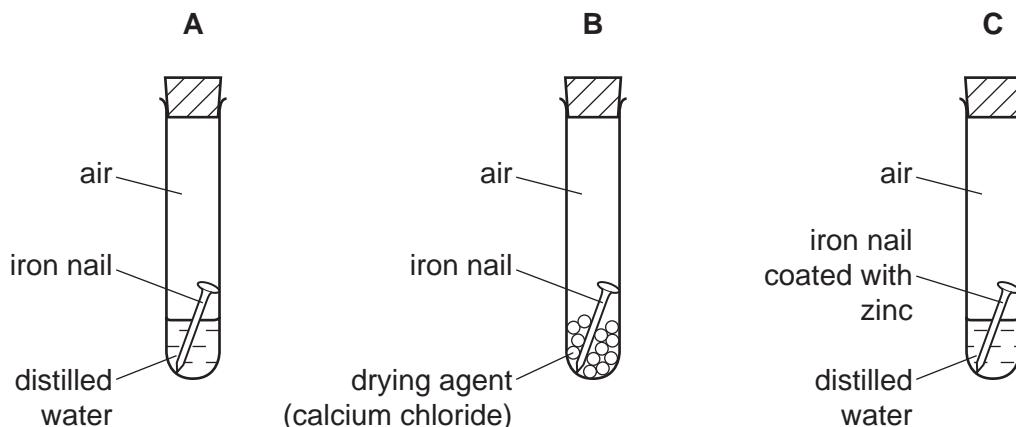

(a) For each tube **A**, **B** and **C** predict whether the nails will rust. In each case give a reason.

tube **A**: does the nail rust? .....

reason .....

tube **B**: does the nail rust? .....

reason .....

tube **C**: does the nail rust? .....

reason .....

[3]

(b) Iron from the blast furnace contains impurities such as carbon, phosphorus, silicon and sulfur.  
Describe how the level of these impurities is decreased when steel is made from impure iron.

.....  
.....  
.....  
..... [3]

(c) State a use for stainless steel.

..... [1]

(d) Pure iron can be prepared by the reduction of iron(II) oxide, FeO.

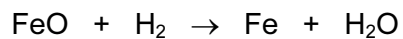

Explain how this equation shows that the iron(II) oxide has been reduced.

.....  
..... [1]

(e) Iron(II) oxide reacts with acids.

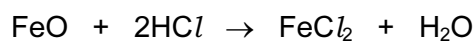

Write a word equation for this reaction.

..... [2]

[Total: 10]

For  
Examiner's  
Use



**BLANK PAGE**

**BLANK PAGE**

**BLANK PAGE**

